

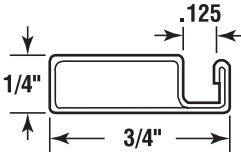
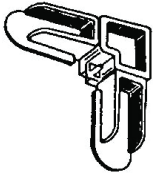

# SECTION 10 / WINDOW SCREEN FRAME & COMPONENTS

PRODUCT	PAGE
Screen frame w/corners (1/4" thru 1-1/4").....	98-103
Lip & stand-off screen frame w/corners.....	104
Spreader bar & clips .....	105
Screen slide channels, mullion & screen circles .....	106
Adjustable corners, wickets (plastic & metal).....	107
Die-cast screen clips .....	108
Plastic screen clips.....	108
Casement clips .....	108
Retainer clips & pull tabs.....	109
Screen tension springs (flat & corner mount) & screen hangers.....	109
Jiffy hangers & bail latches .....	110
Plunger latches & slide locks .....	110
Screen frame order guide.....	111

# 1/4" ALUMINUM SCREEN FRAME & CORNERS

SER-123	Part No.	Length	Pcs/Carton	Ft./Carton	Thickness	Finish
3/4" x 1/4" Screen frame  Use spline size: .135 (Aluminum mesh) .150 (Fiberglass mesh)	123ML122-BX	12'2"	90	1095'	.020	Mill/Unpainted
	123BZ122-BX	12'2"	90	1095'	.020	Bronze
	123WH122-BX	12'2"	90	1095'	.020	White
	Part No.	Length	Pcs/Bundle	Ft./Bundle	Thickness	Finish
	123ML122-BN	12'2"	50	608'	.020	Mill/Unpainted
	123BZ122-BN	12'2"	50	608'	.020	Bronze
	123WH122-BN	12'2"	50	608'	.020	White
	123ML122-PK	12'2"	10	122'	.020	Mill/Unpainted
	123BZ122-PK	12'2"	10	122'	.020	Bronze
	123WH122-PK	12'2"	10	122'	.020	White
Part No.	Pcs/Bag	Pcs/Carton	Finish			
3/4" x 1/4" Plastic corner 	C123GR	100	1000	Gray		
	C123BZ	100	1000	Bronze		
	C123WH	100	1000	White		
Part No.	Pcs/Bag	Pcs/Carton	Thickness	Finish		
3/4" x 1/4" Miter cut corner 	C123ML-035	100	1000	.035	Mill/Unpainted	

**NOTE:**

50 piece bundles and 10 piece poly bagged packs available on most lineal items  
 Less than pack quantities available on selected items only  
 Screen corners now available in 100 piece poly bags

# 5/16" ALUMINUM SCREEN FRAME & CORNERS

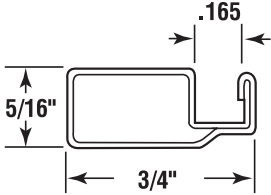
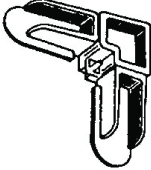
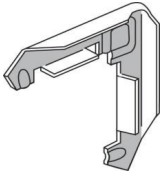
SER-520	Part No.	Length	Pcs/Carton	Ft./Carton	Thickness	Finish
<p>3/4" x 5/16" Screen frame</p>  <p>Use spline size:                      .165 (Aluminum mesh)                      .185 (Fiberglass mesh)</p>	520ML122-BX	12'2"	100	1217'	.020	Mill/Unpainted
	520GR122-BX	12'2"	100	1217'	.020	Gray
	520BZ122-BX	12'2"	100	1217'	.020	Bronze
	520WH122-BX	12'2"	100	1217'	.020	White
	520AL122-BX	12'2"	100	1217'	.020	Almond
	520AD122-BX	12'2"	100	1217'	.020	Adobe
	Part No.	Length	Pcs/Bundle	Ft./Bundle	Thickness	Finish
	520ML122-BN	12'2"	50	608'	.020	Mill/Unpainted
	520GR122-BN	12'2"	50	608'	.020	Gray
	520BZ122-BN	12'2"	50	608'	.020	Bronze
	520WH122-BN	12'2"	50	608'	.020	White
	520AL122-BN	12'2"	50	608'	.020	Almond
	520AD122-BN	12'2"	50	608'	.020	Adobe
	520ML122-PK	12'2"	10	122'	.020	Mill/Unpainted
520GR122-PK	12'2"	10	122'	.020	Gray	
520BZ122-PK	12'2"	10	122'	.020	Bronze	
520WH122-PK	12'2"	10	122'	.020	White	
520AL122-PK	12'2"	10	122'	.020	Almond	
520AD122-PK	12'2"	10	122'	.020	Adobe	
Part No.	Pcs/Bag	Pcs/Carton	Finish			
<p>3/4" x 5/16" Plastic corner</p> 	C520GR	100	1000	Gray		
	C520BZ	100	1000	Bronze		
	C520WH	100	1000	White		
	C520AL	100	1000	Almond		
Part No.	Pcs/Bag	Pcs/Carton	Thickness	Finish		
<p>3/4" x 5/16" Miter cut corner</p> 	C520ML-040	100	1000	.040	Mill/Unpainted	

**NOTE:**

50 piece bundles and 10 piece poly bagged packs available on most lineal items  
 Less than pack quantities available on selected items only  
 Screen corners now available in 100 piece poly bags

# 3/8" ALUMINUM SCREEN FRAME & CORNERS

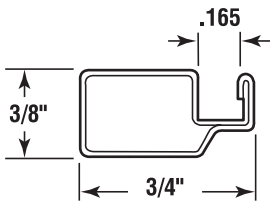
SER-519	Part No.	Length	Pcs/Carton	Ft./Carton	Thickness	Finish
<p>3/4" x 3/8" Screen frame</p>  <p>SER-119 = .020 SER-119E = .018 SER-119H = .025</p> <p>Use spline size: .165 (Aluminum mesh) .185 (Fiberglass mesh)</p>	519ML122-BX	12'2"	100	1217'	.020	Mill/Unpainted
	519GR122-BX	12'2"	100	1217'	.020	Gray
	519BZ122-BX	12'2"	100	1217'	.020	Bronze
	519WH122-BX	12'2"	100	1217'	.020	White
	519AL122-BX	12'2"	100	1217'	.020	Almond
	519AD122-BX	12'2"	100	1217'	.020	Adobe
	Part No.	Length	Pcs/Bundle	Ft./Bundle	Thickness	Finish
	519ML122-BN	12'2"	50	608'	.020	Mill/Unpainted
	519GR122-BN	12'2"	50	608'	.020	Gray
	519BZ122-BN	12'2"	50	608'	.020	Bronze
	519WH122-BN	12'2"	50	608'	.020	White
	519AL122-BN	12'2"	50	608'	.020	Almond
	519AD122-BN	12'2"	50	608'	.020	Adobe
	519ML122-PK	12'2"	10	122'	.020	Mill/Unpainted
	519GR122-PK	12'2"	10	122'	.020	Gray
	519BZ122-PK	12'2"	10	122'	.020	Bronze
	519WH122-PK	12'2"	10	122'	.020	White
	519AL122-PK	12'2"	10	122'	.020	Almond
	519AD122-PK	12'2"	10	122'	.020	Adobe
	Part No.	Length	Pcs/Carton	Ft./Carton	Thickness	Finish
	519ML122H-BX	12'2"	100	1217'	.025	Mill/Unpainted
	519GR122H-BX	12'2"	100	1217'	.025	Gray
	519BZ122H-BX	12'2"	100	1217'	.025	Bronze
	519WH122H-B	12'2"	100	1217'	.025	White
	Part No.	Length	Pcs/Bundle	Ft./Bundle	Thickness	Finish
	519ML122H-BN	12'2"	50	608'	.025	Mill/Unpainted
	519GR122H-BN	12'2"	50	608'	.025	Gray
	519BZ122H-BN	12'2"	50	608'	.025	Bronze
519WH122H-BN	12'2"	50	608'	.025	White	
519ML122H-PK	12'2"	10	122'	.025	Mill/Unpainted	
519GR122H-PK	12'2"	10	122'	.025	Gray	
519BZ122H-PK	12'2"	10	122'	.025	Bronze	
519WH122H-PK	12'2"	10	122'	.025	White	
Part No.	Length	Pcs/Bag	Pcs/Carton	Thickness	Finish	
3/4" x 3/8" Plastic corner	C119GR	100			Gray	
	C119BZ	100			Bronze	
	C119WH	100			White	
	C119AL	100			Almond	
Part No.	Length	Pcs/Bag	Pcs/Carton	Thickness	Finish	
3/4" x 3/8" Miter cut corner	C519ML-050	100	1000	.050	Mill/Unpainted	

# 7/16" ALUMINUM SCREEN FRAME & CORNERS

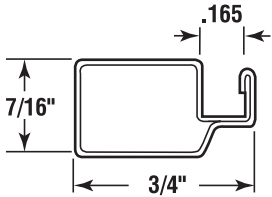

SER-516	Part No.	Length	Pcs/Carton	Ft./Carton	Thickness	Finish
<p>3/4" x 7/16" Screen frame</p>  <p>SER-115 = .025 SER-116 = .020 SER-116E = .018</p> <p>Use spline size: .165 (Aluminum mesh) .185 (Fiberglass mesh)</p>	516ML122-BX	12'2"	100	1217'	.020	Mill/Unpainted
	516GR122-BX	12'2"	100	1217'	.020	Gray
	516BZ122-BX	12'2"	100	1217'	.020	Bronze
	516WH122-BX	12'2"	100	1217'	.020	White
	516AL122-BX	12'2"	100	1217'	.020	Almond
	516AD122-BX	12'2"	100	1217'	.020	Adobe
	Part No.	Length	Pcs/Bundle	Ft./Bundle	Thickness	Finish
	516ML122-BN	12'2"	50	608'	.020	Mill/Unpainted
	516GR122-BN	12'2"	50	608'	.020	Gray
	516BZ122-BN	12'2"	50	608'	.020	Bronze
	516WH122-BN	12'2"	50	608'	.020	White
	516AL122-BN	12'2"	50	608'	.020	Almond
	516AD122-BN	12'2"	50	608'	.020	Adobe
	516ML122-PK	12'2"	10	122'	.020	Mill/Unpainted
	516GR122-PK	12'2"	10	122'	.020	Gray
	516BZ122-PK	12'2"	10	122'	.020	Bronze
	516WH122-PK	12'2"	10	122'	.020	White
	516AL122-PK	12'2"	10	122'	.020	Almond
	516AD122-PK	12'2"	10	122'	.020	Adobe
	Part No.	Length	Pcs/Carton	Ft./Carton	Thickness	Finish
	515ML122-BX	12'2"	100	1217'	.025	Mill/Unpainted
	515GR122-BX	12'2"	100	1217'	.025	Gray
	515BZ122-BX	12'2"	100	1217'	.025	Bronze
	515WH122-BX	12'2"	100	1217'	.025	White
	Part No.	Length	Pcs/Bundle	Ft./Bundle	Thickness	Finish
	515ML122-BN	12'2"	50	608'	.025	Mill/Unpainted
	515GR122-BN	12'2"	50	608'	.025	Gray
	515BZ122-BN	12'2"	50	608'	.025	Bronze
515WH122-BN	12'2"	50	608'	.025	White	
515ML122-PK	12'2"	10	122'	.025	Mill/Unpainted	
515GR122-PK	12'2"	10	122'	.025	Gray	
515BZ122-PK	12'2"	10	122'	.025	Bronze	
515WH122-PK	12'2"	10	122'	.025	White	
Part No.	Pcs/Bag	Pcs/Carton	Thickness	Finish		
3/4" x 7/16" Plastic corner	C116GR	100	1000		Gray	
	C116BZ	100	1000		Bronze	
	C116WH	100	1000		White	
	C116AL	100	1000		Almond	
Part No.	Pcs/Bag	Pcs/Carton	Thickness	Finish		
3/4" x 7/16" Miter cut corner	C515ML-050	100	1000	.050	Mill/Unpainted	

# 1" ALUMINUM SCREEN FRAME & CORNERS

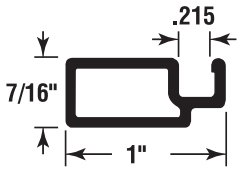
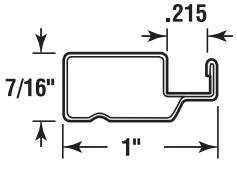
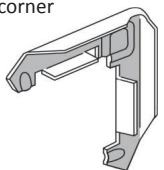
Item packs marked with "\*"available in less than pack quantities

SER-114	Part No.	Length	Pcs/Carton	Ft./Carton	Thickness	Finish
<b>1" Extruded screen frame</b>  Use spline size: .235 (Aluminum mesh) .250 (Fiberglass mesh) <b>Use corner C114ML-040</b>	114ML122-BX	12'2"	50	608'	.050	Mill/Unpainted
	114SA122-BX	12'2"	50	608'	.050	Satin anodized
	114BZ122-BX	12'2"	50	608'	.050	Bronze
	114BA122-BX	12'2"	50	608'	.050	Bronze anodized
	114WH122-BX	12'2"	50	608'	.050	White
	114AL122-BX	12'2"	50	608'	.050	Almond
	Part No.	Length	Pcs/Bundle	Ft./Bundle	Thickness	Finish
	114ML122-PK	12'2"	10*	122'	.050	Mill/Unpainted
	114SA122-PK	12'2"	10*	122'	.050	Satin anodized
	114BZ122-PK	12'2"	10*	122'	.050	Bronze
	114BA122-PK	12'2"	10*	122'	.050	Bronze anodized
	114WH122-PK	12'2"	10*	122'	.050	White
	114AL122-PK	12'2"	10*	122'	.050	Almond
	SER-112	Part No.	Length	Pcs/Carton	Ft./Carton	Thickness
<b>1" Screen frame</b>  SER-112 = .032 SER-513 = .025 Use spline size: .235 (Aluminum mesh) .250 (Fiberglass mesh) <b>Use corner C112ML-xxx</b>	112ML122-BX	12'2"	65	791'	.032	Mill/Unpainted
	112GR122-BX	12'2"	65	791'	.032	Gray
	112BZ122-BX	12'2"	65	791'	.032	Bronze
	112WH122-BX	12'2"	65	791'	.032	White
	Part No.	Length	Pcs/Bundle	Ft./Bundle	Thickness	Finish
	112ML122-PK	12'2"	10	122'	.032	Mill/Unpainted
	112GR122-PK	12'2"	10	122'	.032	Gray
	112BZ122-PK	12'2"	10	122'	.032	Bronze
	112WH122-PK	12'2"	10	122'	.032	White
	Part No.	Length	Pcs/Carton	Ft./Carton	Thickness	Finish
	513ML122-BX	12'2"	84	1022'	.025	Mill/Unpainted
	513GR122-BX	12'2"	84	1022'	.025	Gray
	513BZ122-BX	12'2"	84	1022'	.025	Bronze
	513WH122-BX	12'2"	84	1022'	.025	White
	513AL122-BX	12'2"	84	1022'	.025	Almond
	513AD122-BX	12'2"	84	1022'	.025	Adobe
	Part No.	Length	Pcs/Bundle	Ft./Bundle	Thickness	Finish
	513ML122-PK	12'2"	10	122'	.025	Mill/Unpainted
	513GR122-PK	12'2"	10	122'	.025	Gray
	513BZ122-PK	12'2"	10	122'	.025	Bronze
513WH122-PK	12'2"	10	122'	.025	White	
513AL122-PK	12'2"	10	122'	.025	Almond	
513AD122-PK	12'2"	10	122'	.025	Adobe	
Part No.	Length	Pcs/Bag	Pcs/Carton	Thickness	Finish	
<b>1" x 7/16" Miter cut corner</b> 	C112ML-050		100	1000	.050	Mill/Unpainted
	C112ML-060		100	1000	.060	Mill/Unpainted
	C114ML-040		100	1000	0.04	Mill/Unpainted
	C513ML-060		100	1000	0.06	Mill/Unpainted

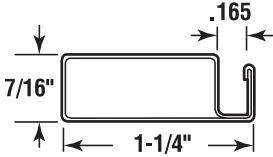

# 1-1/4" ALUMINUM SCREEN FRAME & CORNERS

SER-111	Part No.	Length	Pcs/Carton	Ft./Carton	Thickness	Finish
1-1/4" x 7/16" Screen frame  Use spline size: .165 (Aluminum mesh) .185 (Fiberglass mesh) <b>Use corner C111ML-060</b>	111BZ122-BX	12'2"	65	791'	.040	Bronze
	Part No.	Length	Pcs/Bundle	Ft./Bundle	Thickness	Finish
	111BZ122-PK	12'2"	10	122'	.040	Bronze
Part No.		Pcs/Bag	Pcs/Carton	Thickness	Finish	
1-1/4" x 7/16" Miter cut corner	C111ML-060	100	1000	.060	Mill/Unpainted	
						

**NOTE:**

50 piece bundles and 10 piece poly bagged packs available on most lineal items  
 Less than pack quantities available on selected items only  
 Screen corners now available in 100 piece poly bags

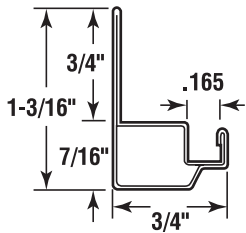
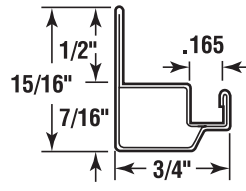
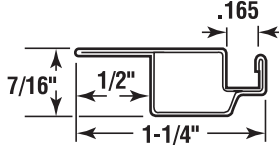
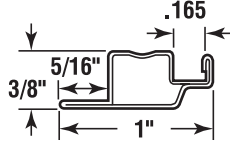
# LIP & STAND-OFF ALUMINUM SCREEN FRAME

SER-124	Part No.	Length	Pcs/Carton	Ft./Carton	Thickness	Finish
3/4" Stand-off frame  Use corner C115ML-xxx	124ML122-BX	12'2"	60	730'	.025	Mill/Unpainted
	124GR122-BX	12'2"	60	730'	.025	Gray
	124BZ122-BX	12'2"	60	730'	.025	Bronze
	124WH122-BX	12'2"	60	730'	.025	White
	124AL122-BX	12'2"	60	730'	.025	Almond
	124AD122-BX	12'2"	60	730'	.025	Adobe
	Part No.	Length	Pcs/Bundle	Ft./Bundle	Thickness	Finish
	124ML122-PK	12'2"	10	122'	.025	Mill/Unpainted
	124GR122-PK	12'2"	10	122'	.025	Gray
	124BZ122-PK	12'2"	10	122'	.025	Bronze
	124WH122-PK	12'2"	10	122'	.025	White
	124AL122-PK	12'2"	10	122'	.025	Almond
	124AD122-PK	12'2"	10	122'	.025	Adobe
SER-129	Part No.	Length	Pcs/Carton	Ft./Carton	Thickness	Finish
1/2" Stand-off frame  Use corner C115ML-040 or AC115BK (adjustable)	129ML122-BX	12'2"	90	1095'	.025	Mill/Unpainted
	129GR122-BX	12'2"	90	1095'	.025	Gray
	129BZ122-BX	12'2"	90	1095'	.025	Bronze
	129WH122-BX	12'2"	90	1095'	.025	White
	Part No.	Length	Pcs/Bundle	Ft./Bundle	Thickness	Finish
	129ML122-PK	12'2"	10	122'	.025	Mill/Unpainted
	129GR122-PK	12'2"	10	122'	.025	Gray
	129BZ122-PK	12'2"	10	122'	.025	Bronze
	129WH122-PK	12'2"	10	122'	.025	White
	SER-118	Part No.	Length	Pcs/Carton	Ft./Carton	Thickness
1/2" Lip frame  Use corner C115ML-040 or AC115BK (adjustable)	118ML122-BX	12'2"	70	852'	.025	Mill/Unpainted
	118GR122-BX	12'2"	70	852'	.025	Gray
	118BZ122-BX	12'2"	70	852'	.025	Bronze
	118WH122-BX	12'2"	70	852'	.025	White
	Part No.	Length	Pcs/Bundle	Ft./Bundle	Thickness	Finish
	118ML122-PK	12'2"	10	122'	.025	Mill/Unpainted
	118GR122-PK	12'2"	10	122'	.025	Gray
	118BZ122-PK	12'2"	10	122'	.025	Bronze
	118WH122-PK	12'2"	10	122'	.025	White
	SER-117	Part No.	Length	Pcs/Carton	Ft./Carton	Thickness
5/16" Lip frame  All above use spline size: .165 (Aluminum mesh) .185 (Fiberglass mesh) Use corner C117ML-020	117ML122-BX	12'2"	120	1460'	.020	Mill/Unpainted
	117GR122-BX	12'2"	120	1460'	.020	Gray
	117BZ122-BX	12'2"	120	1460'	.020	Bronze
	117WH122-BX	12'2"	120	1460'	.020	White
	117AL122-BX	12'2"	120	1460'	.020	Almond
	117AD122-BX	12'2"	120	1460'	.020	Adobe
	Part No.	Length	Pcs/Bundle	Ft./Bundle	Thickness	Finish
	117ML122-PK	12'2"	10	122'	.020	Mill/Unpainted
	117GR122-PK	12'2"	10	122'	.020	Gray
	117BZ122-PK	12'2"	10	122'	.020	Bronze
	117WH122-PK	12'2"	10	122'	.020	White
	117AL122-PK	12'2"	10	122'	.020	Almond
	117AD122-PK	12'2"	10	122'	.020	Adobe
	Corners	Description	Part No.	Pcs/Bag	Pcs/Carton	Thickness
	5/16" Lip frame corner	C117ML-020	100	1000	.020	Mill/Unpainted
	3/4" x 7/16" Miter cut corner	C115ML-040	100	1000	.040	Mill/Unpainted
	3/4" x 7/16" Miter cut corner	C115ML-050	100	1000	.050	Mill/Unpainted

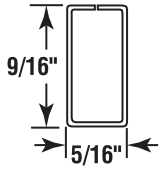
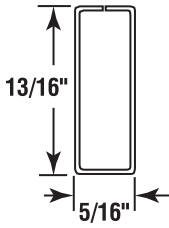
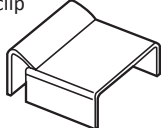
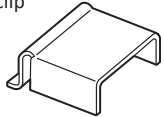

# ALUMINUM SCREEN FRAME SPREADER BAR

SER-128	Part No.	Length	Pcs/Carton	Ft./Carton	Thickness	Finish
5/8" Spreader bar 	128ML120-BX	12'0"	100	1200'	.025	Mill/Unpainted
	128GR120-BX	12'0"	100	1200'	.025	Gray
	128BZ120-BX	12'0"	100	1200'	.025	Bronze
	128WH120-BX	12'0"	100	1200'	.025	White
	128AL120-BX	12'0"	100	1200'	.025	Almond
	128AD120-BX	12'0"	100	1200'	.025	Adobe
	Part No.	Length	Pcs/Bundle	Ft./Bundle	Thickness	Finish
	128ML120-BN	12'0"	50	600'	.025	Mill/Unpainted
	128GR120-BN	12'0"	50	600'	.025	Gray
	128BZ120-BN	12'0"	50	600'	.025	Bronze
	128WH120-BN	12'0"	50	600'	.025	White
	128AL120-BN	12'0"	50	600'	.025	Almond
	128AD120-BN	12'0"	50	600'	.025	Adobe
	128ML120-PK	12'0"	10	120'	.025	Mill/Unpainted
	128GR120-PK	12'0"	10	120'	.025	Gray
	128BZ120-PK	12'0"	10	120'	.025	Bronze
	128WH120-PK	12'0"	10	120'	.025	White
	128AL120-PK	12'0"	10	120'	.025	Almond
	128AD120-PK	12'0"	10	120'	.025	Adobe
	SER-127	Part No.	Length	Pcs/Carton	Ft./Carton	Thickness
7/8" Spreader bar 	127ML120-BX	12'0"	75	900'	.030	Mill/Unpainted
	127GR120-BX	12'0"	75	900'	.030	Gray
	127BZ120-BX	12'0"	75	900'	.030	Bronze
	127WH120-BX	12'0"	75	900'	.030	White
	127AL120-BX	12'0"	75	900'	.030	Almond
	127AD120-BX	12'0"	75	900'	.030	Adobe
	Part No.	Length	Pcs/Bundle	Ft./Bundle	Thickness	Finish
	127ML120-PK	12'0"	10	120'	.030	Mill/Unpainted
	127GR120-PK	12'0"	10	120'	.030	Gray
	127BZ120-PK	12'0"	10	120'	.030	Bronze
	127WH120-PK	12'0"	10	120'	.030	White
	127AL120-PK	12'0"	10	120'	.030	Almond
	127AD120-PK	12'0"	10	120'	.030	Adobe
	Part No.	Pcs/Bag	Pcs/Carton	Finish		
7/8" Spreader bar clip	159ML	100	1000	Mill/Unpainted		
						
Part No.	Pcs/Bag	Pcs/Carton	Finish			
5/8" Spreader bar clip	160ML	100	1000	Mill/Unpainted		
						

# ALUMINUM SCREEN FRAME ACCESSORIES

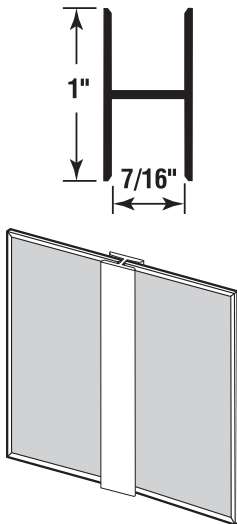
SER-130	Part No.	Length	Pcs/Carton	Ft./Carton	Thickness	Finish
3/4" Stand-off frame 	130ML122-BX	12'2"	50	610'	.025	Mill/Unpainted
	130SA122-BX	12'2"	50	610'	.025	Satin anodized
	130BZ122-BX	12'2"	50	610'	.025	Bronze
	130WH122-BX	12'2"	50	610'	.025	White
	130AL122-BX	12'2"	50	610'	.025	Almond
	130AD122-BX	12'2"	50	610'	.025	Adobe
	Part No.	Length	Pcs/Bundle	Ft./Bundle	Thickness	Finish
	130ML122-PK	12'2"	10	122'	.025	Mill/Unpainted
	130SA122-PK	12'2"	10	122'	.025	Satin anodized
	130BZ122-PK	12'2"	10	122'	.025	Bronze
	130WH122-PK	12'2"	10	122'	.025	White
	130AL122-PK	12'2"	10	122'	.025	Almond
	130AD122-PK	12'2"	10	122'	.025	Adobe
	130ML122-EA	12'2"	1	12'2"	.025	Mill/Unpainted
	130SA122-EA	12'2"	1	12'2"	.025	Satin anodized
	130BZ122-EA	12'2"	1	12'2"	.025	Bronze
	130WH122-EA	12'2"	1	12'2"	.025	White
	130AL122-EA	12'2"	1	12'2"	.025	Almond
	130AD122-EA	12'2"	1	12'2"	.025	Adobe

SER-185	Part No.	Description	Diameters (all colors)	Finish
1" Screen frame circles  <p><i>Only sold in packs of 5</i></p>	185GR.xx	.025 Ga. 1" Screen frame circles Full circles only	24", 30", 36" 42", 48", 60" 72", 84", 96"	Gray
	185BZ.xx			Bronze
	185WH.xx			White
	185AL.xx			Almond
	185AD.xx			Adobe

**NOTE:**

50 piece bundles and 10 piece poly bagged packs available on most lineal items  
 Less than pack quantities available on selected items only  
 Screen corners now available in 100 piece poly bags



# SCREEN FRAME ACCESSORIES

## ADJUSTABLE CORNERS

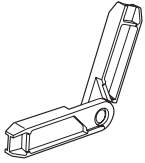
	Part No.	Size	Product Line	Pack QTY	Description	Finish
	AC115BK	3/4" x 7/16"	D1110	20/Bag	135° Plastic miter cut <i>Fits Precision 3/4" x 7/16" frame</i>	Black
	AC1130BK	1" x 7/16"	D1110	20/Bag	135° Plastic miter cut <i>Fits Precision 1" x 7/16" roll form frame</i>	Black

## PLASTIC WICKETS

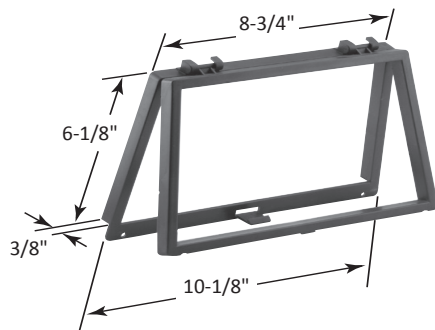

Part No.	Product Line	Color
190GR	A1150	Gray
190BZ	A1150	Bronze
190WH	A1150	White

- Allows access to awning or casement window operators.
- Available in three colors: gray, bronze, and white.
- Use either aluminum or fiberglass screen mesh to match the existing mesh in window screen.
- Requires a 12" minimum window screen width.

## ALUMINUM WICKETS

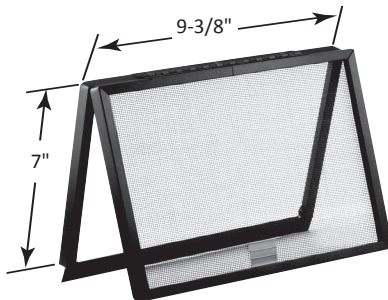

Part No.	Product Line	Color
188ML	A1150	Mill w/gray fiberglass
188BZ	A1150	Bronze
188WH	A1150	White
189ML	A1150	Mill w/charcoal fiberglass

# SCREEN FRAME ACCESSORIES

## DIECAST SCREEN CLIPS (Product Line: A1211)

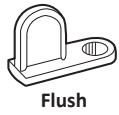

Size	Use screw #	Pack QTY	Adobe	Almond	Black	Bronze	Mill	White
Flush	#1052 Screw (10-24 x 5/8" S/T)	100/Bag	1660AD	1660AL	1660BK	1660BZ	1660ML	1660WH
1/16"	#1052 Screw (10-24 x 5/8" S/T)	100/Bag	1661AD	1661AL	1661BK	1661BZ	1661ML	1661WH
1/8"	#1052 Screw (10-24 x 5/8" S/T)	100/Bag	1662AD	1662AL	1662BK	1662BZ	1662ML	1662WH
3/16"	#1052 Screw (10-24 x 5/8" S/T)	100/Bag	1663AD	1663AL	1663BK	1663BZ	1663ML	1663WH
1/4"	#1052 Screw (10-24 x 5/8" S/T)	100/Bag	1664AD	1664AL	1664BK	1664BZ	1664ML	1664WH
5/16"	#1052 Screw (10-24 x 5/8" S/T)	100/Bag	1665AD	1665AL	1665BK	1665BZ	1665ML	1665WH
3/8"	#1052 Screw (10-24 x 5/8" S/T)	100/Bag	1666AD	1666AL	1666BK	1666BZ	1666ML	1666WH
7/16"	#1053 Screw (10-24 x 3/4" S/T)	100/Bag	1667AD	1667AL	1667BK	1667BZ	1667ML	1667WH
1-3/16"	#1055 Screw (10-24 x 1-5/8" S/T)	100/Bag	1668AD	1668AL	1668BK	1668BZ	1668ML	1668WH

All clips available in 1000 pieces per carton

## PLASTIC SCREEN CLIPS (Product Line: D1310)

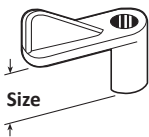
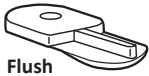

Size	Use screw #	Pack QTY	Black	Bronze	Gray	White
Flush	#1052 Screw (10-24 x 5/8" S/T)	100/Bag	—	—	—	194WH
1/16"	#1052 Screw (10-24 x 5/8" S/T)	100/Bag	—	170BZ	170GR	170WH
5/16"	#1052 Screw (10-24 x 5/8" S/T)	100/Bag	—	171BZ	171GR	—
3/8"	#1052 Screw (10-24 x 5/8" S/T)	100/Bag	—	172BZ	172GR	—
7/16"	#1053 Screw (10-24 x 3/4" S/T)	100/Bag	173BK	173BZ	173GR	173WH
1-3/16"	#1055 Screw (10-24 x 1-5/8" S/T)	100/Bag	—	197BZ	197GR	—

All clips available in 1000 pieces per carton

## CASEMENT CLIPS (Product Line: D1310)

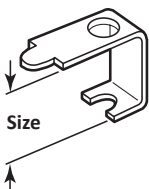

Size	Use screw #	Pack QTY	Part No.	Finish
5/16"	#1052 Screw (10-24 x 5/8" S/T)	1000/Ctn.	1780ML	Mill
3/8"	#1053 Screw (10-24 x 3/4" S/T)	1000/Ctn.	179ML	Mill
7/16"	#1053 Screw (10-24 x 3/4" S/T)	1000/Ctn.	180ML	Mill
7/8"	#1054 Screw (10-24 x 1-1/4" S/T)	1000/Ctn.	181ML	Mill
1-3/16"	#1055 Screw (10-24 x 1-5/8" S/T)	1000/Ctn.	182ML	Mill



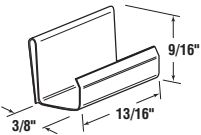
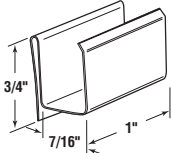
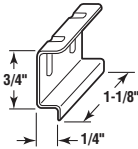
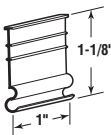
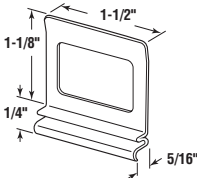

# SCREEN FRAME ACCESSORIES

## RETAINER CLIPS & PULL TABS (Product Line: D1310)

	Description	Material	Pack QTY	Mill	Black	White	Gray
	Retainer clips <i>For 3/8" frame</i>	Spring steel	1000/Ctn.	164ML	—	—	—
	Retainer clips <i>For 7/16" frame</i>	Spring steel	1000/Ctn.	165ML	—	—	—
	Spline channel pull tabs	Aluminum	1000/Ctn.	152ML	—	152WH	—
	Spline channel pull tabs	Plastic	1000/Ctn.	—	153BK	—	153GR
	Spline channel pull tabs	Plastic	1000/Ctn.	—	154BK	—	—

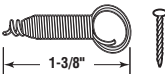
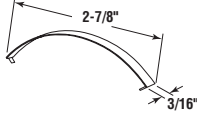
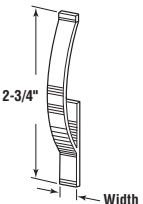
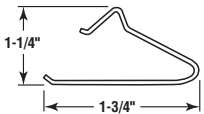
## SPRINGS (Product Line: D1310)

	Description	Material	Pack QTY	Part No.
	Bottom latch springs	Stainless steel	1000/Ctn.	1550SS
	Flat springs	Spring steel	1000/Ctn.	1510ZP
	Flat springs <i>1/4" wide</i>	Spring steel	1000/Ctn.	1490ZP
	Flat springs <i>3/16" wide</i>	Spring steel	1000/Ctn.	1560ZP
	Wire springs	Spring steel	1000/Ctn.	1740CP
	Cone springs	Spring steel	1000/Ctn.	1630CP

See Prime-Line's Professional Backroom Window & Screen Repair Catalog for complete listing of replacement hardware

# SCREEN FRAME ACCESSORIES

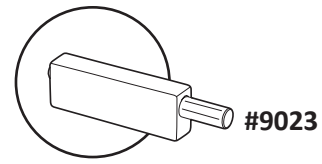

## JIFFY HANGERS & BAIL LATCHES

	Material	Pack QTY	Finish	Part No.	Product Line
(2) Hangers & (1) latch <b>For 7/16" frame</b>  <b>1 Set contains:</b> 2 Hangers, 1 latch, (2) 13 x 3/4" spiral steel nails & 1 ball head screw	Aluminum	250 Sets / Box	Mill	146ML	A1210
	Aluminum	250 Sets / Box	Bronze	146BZ	A1210
	Aluminum	250 Sets / Box	White	146WH	A1210
	Aluminum	250 Sets / Box	Gray	146GR	A1210
Top hangers <b>For 7/16" frame</b> w/spiral steel nails	Aluminum	1000 / Box	Mill	144ML	A1210
	Aluminum	1000 / Box	Bronze	144BZ	A1210
	Aluminum	1000 / Box	White	144WH	A1210
	Aluminum	1000 / Box	Gray	144GR	A1210
Bottom latches <b>For 7/16" frame</b>	Aluminum	1000 / Box	Mill	145ML	A1210
	Aluminum	1000 / Box	Bronze	145BZ	A1210
	Aluminum	1000 / Box	White	145WH	A1210
	Aluminum	1000 / Box	Gray	145GR	A1210
Knife latches Use notching tool #9025	Aluminum	100 Pair	Mill	175ML	D1310

## PLUNGER LATCHES & SLIDE LOCKS

	Material	Pack QTY	Part No.	Product Line
Plunger latches <b>For 3/4" x 3/8"</b> <b>(or 7/16") frame</b>  Use step drill #9017 <b>SNAP-ON STYLE</b>	Black nylon	500 Sets	176BK	D1310
Plunger latches <b>For 3/4" x 3/8"</b> <b>(or 7/16") frame</b>  Use step drill #9017 <b>NAIL SET STYLE</b>	All aluminum	100 Sets	176ML	D1310
Plunger latches <b>For 1" x 7/16" Frame</b>  Use step drill #9017 <b>NAIL SET STYLE</b>	All aluminum	100 Sets	177ML	D1310
Slide lock <b>For all 3/4" frames</b>	Zinc plated steel	1000/Ctn.	161ML	D1310
Lock pins <b>For all 3/4" frames</b>	Steel	1000/Ctn.	1580CP	D1310



# SCREEN FRAME ORDER GUIDE

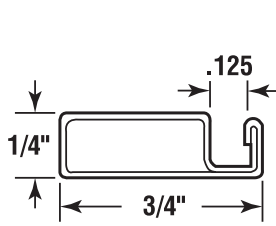

SER-123 (pg. 98)

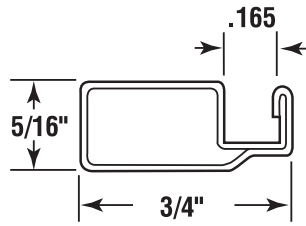

SER-520 (pg. 99)

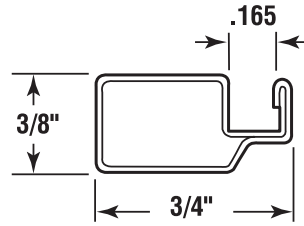

SER-519 (pg. 100)

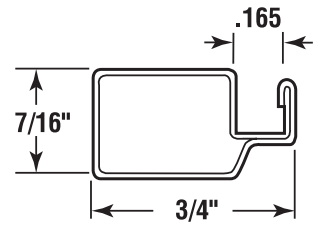

SER-516 (pg. 101)

\* All dimensions are in inches

## -- SPECIFICATIONS --

FRAME:	516 = 3/4" X 7/16" X .020	519 = 3/4" X 3/8" X .020			
	520 = 3/4" X 5/16" X .020	123 = 3/4" X 1/4" X .020			
FINISH:	ML = Mill	GR = Gray	WH = White	BZ = Bronze	AL = Almond
SCREEN:	Choice of Fiberglass; BetterVue Charcoal, 18 x 16 Charcoal or 18 x 16 Gray				
CORNERS:	Aluminum stamped inside corners.				
SPLINE:	Black serrated vinyl				
HARDWARE:	All above prices include: vinyl pull tabs and spring clips.				

## -- OPTIONS --

SPREADER BAR:	\$ .60 per lineal foot for addition of spreader bar.
SCREEN:	Aluminum 18 x 16; Silver = \$.32/Sq. Ft., Black or Charcoal = \$.38 Sq. Ft. Sun Control Charcoal or Gray; Sunscreen = \$1.10/Sq. Ft., Suntex = \$1.48/Sq. Ft. Ultra Vue = \$.52 Sq. Ft.; PetScreen Lite (Tuff Screen) = \$.880/Sq. Ft.

## -- ORDERING GUIDE --

EXAMPLE: 3/4" X 3/8" FRAME WHITE 519WH SIZE 36" X 41"



**CONDITIONS:** Screens ordered cannot be cancelled or returned for credit. All purchases are final. 5 Day lead time. All screens are plastic wrapped together. Contact factory for special packaging charges.

**MEASURING:** Measure exact size required to the nearest 1/16". No deductions or additions will be made at the factory. For pricing use the next largest width or height shown on the price list.

